

Drop-In

Drop-in remote refrigerated well, static with fan (3 GN container capacity)

ITEM # _____

MODEL # _____

NAME # _____

SIS # _____

AIA # _____

341094 (DIIR3)

Drop-in remote refrigerated well, static with fan (3 GN container capacity)

Short Form Specification

Item No.

Designed to be positioned in flush installation providing improved cleanability and suitable for modern design installations. Designed to serve the food in gastronorm containers with a maximum height of 150mm. Food introduced at the correct temperature maintains its core temperature according to Afnor Standards. Automatic defrosting guarantees evaporators clearance and efficient well cooling. Digital control with temperature display with precise adjustment (0,1°C). Fully compliant HACCP digital controls include visible alarms. A constant flow of cold air circulating through the containers guarantees the correct food temperatures. Temperature uniformity and fast cool down times are guaranteed thanks to powerful radial booster fans. Cylindrical stainless steel air diffusers provides a constant air circulation. 84% faster cool down time (than static refrigerated well) reduces energy consumption by allowing the operator to switch the machines on only when needed. Wells in 304 AISI stainless steel with rounded corners to facilitate cleaning operations. The well is also equipped with a drain hole. High-density expanded polyurethane foam with cyclopentane guarantees excellent well insulation to reduce energy dispersion. The bottom is equipped with copper tubes to ensure proper cooling, with this system the air touches the cold surface and gets cooled. Then cooled air is being distributed with radial booster fans. Preadjusted connection to remote cooling unit (not included). Refrigerant type R452a other gases are available on request.

Main Features

- Preadjusted connection to remote cooling unit (not included).
- Suitable for GN 1/1 containers with a maximum height of 150 mm.
- CB and CE certified by a third party notified body.
- Designed to be positioned in flush installation providing improved cleanability and suitable for modern design installations.
- Available drop-in dimensions: 2, 3, 4, 5, 6 GN.
- Designed to serve the food in gastronorm containers.
- Precise temperature control and setting at 0,1°C .
- As standard the product comes with digitally controlled thermostat which is in line of HACCP norms and provides visual alarm as a warning of the increasing or decreasing temperatures.
- Food introduced at the correct temperature maintains its core temperature according to Afnor Standards.
- Automatic defrosting guarantees evaporators clearance and efficient well cooling.
- A constant flow of cold air circulating through the containers guarantees the correct food temperatures. Temperature uniformity and fast cool down times are guaranteed thanks to powerful radial booster fans. Cylindrical stainless steel air diffusers provides a constant air circulation.
- Built-in cooling unit version is available.

Construction

- Well bottom is inclined to facilitate water drainage.
- Environmentally friendly: R452a as refrigerant gas.
- Well in 304 AISI stainless steel with rounded corners to facilitate cleaning operations. The well is also equipped with a drain hole.
- Electronic control with temperature display.
- IPx2 water protection.
- The bottom is equipped with copper tubes to ensure proper cooling, with this system the air touches the cold surface and gets cooled. Then cooled air is being distributed with radial booster fans.

Sustainability

- High-density expanded polyurethane foam with cyclopentane guarantees excellent well insulation to reduce energy dispersion.
- 84% faster cool down time (than static refrigerated well) reduces energy consumption by allowing the operator to switch the machines on only when needed.



APPROVAL: _____

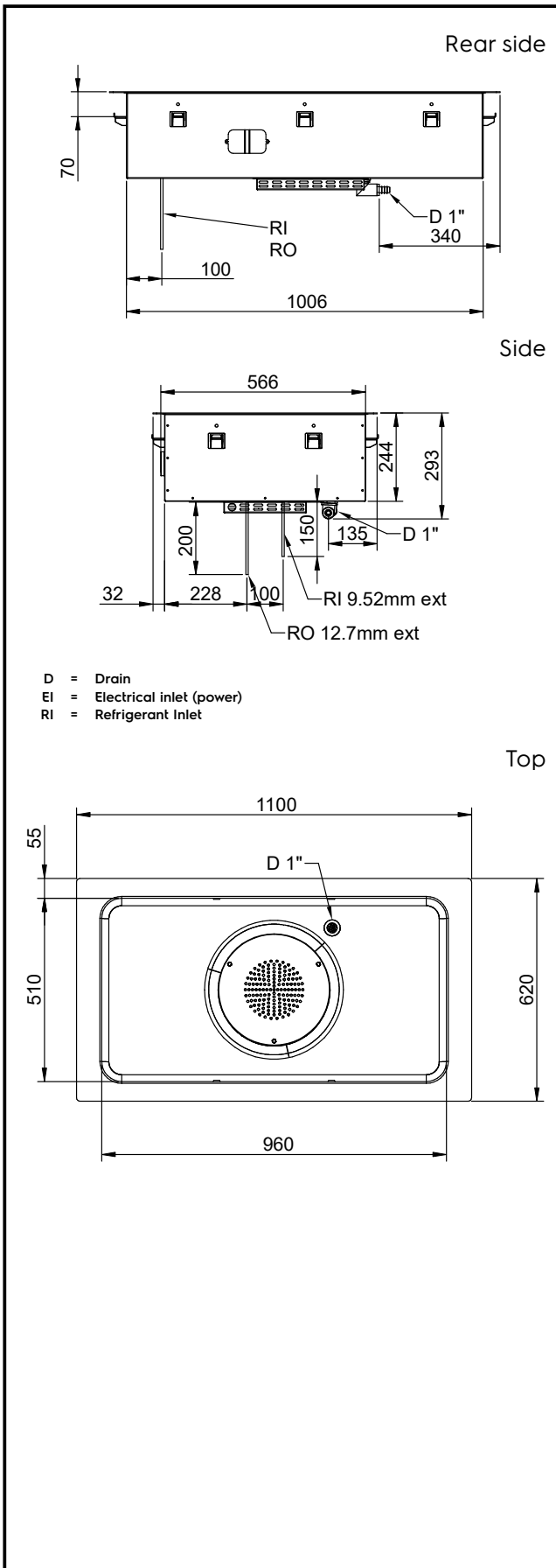

Electric

Supply voltage:
 341094 (D11R3) 220-240 V/1N ph/50 Hz
 Electrical power max.: 0.055 kW

Water:

Water drain outlet size: 1"

Key Information:

External dimensions, Width: 1100 mm
 External dimensions, Depth: 620 mm
 External dimensions, Height: 280 mm
 Net weight: 32.3 kg
 Shipping weight: 46.7 kg
 Shipping height: 400 mm
 Shipping width: 660 mm
 Shipping depth: 1140 mm
 Shipping volume: 0.3 m³
 Set temperature: -10 / 0 °C

Refrigeration Data

Refrigerant type: R452A
 Connection pipes (remote) -
 outlet: 12.7 mm
 Connection pipes (remote) -
 inlet: 9.52 mm

Sustainability

Noise level: 0 dBA

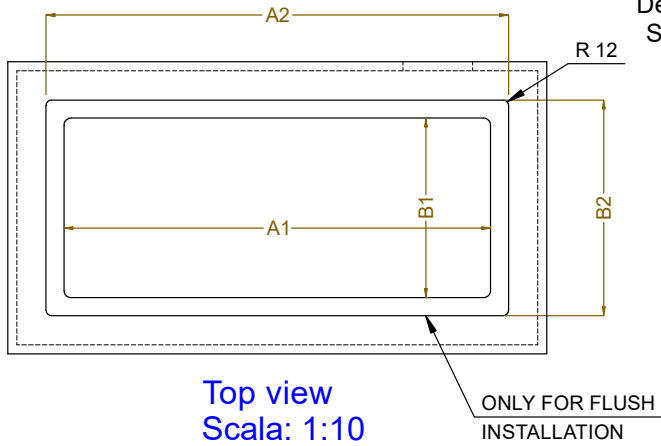
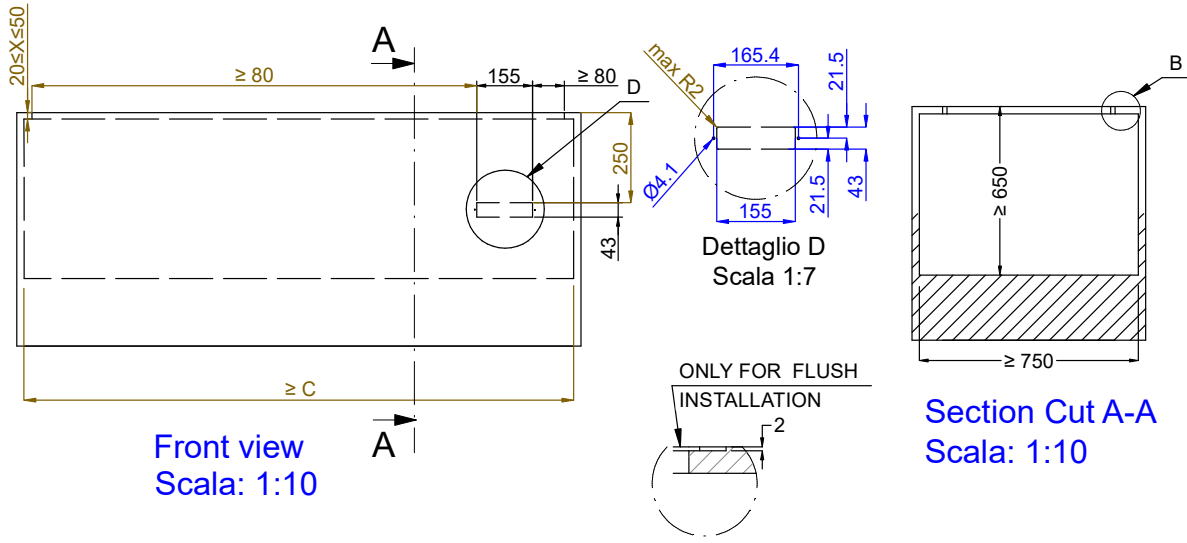

CAPACITY	CUTOUT		LOWERING FOR FLUSH INSTALLATION		C
	A1	B1	A2	B2	
2GN	700	580	774	624	880
3GN	1030		1104		1200
4GN	1350		1424		1530
5GN	1670		1744		1850
6GN	2000		2074		2180

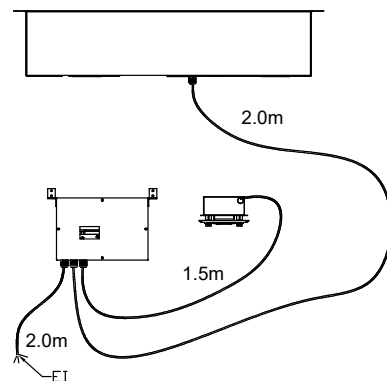
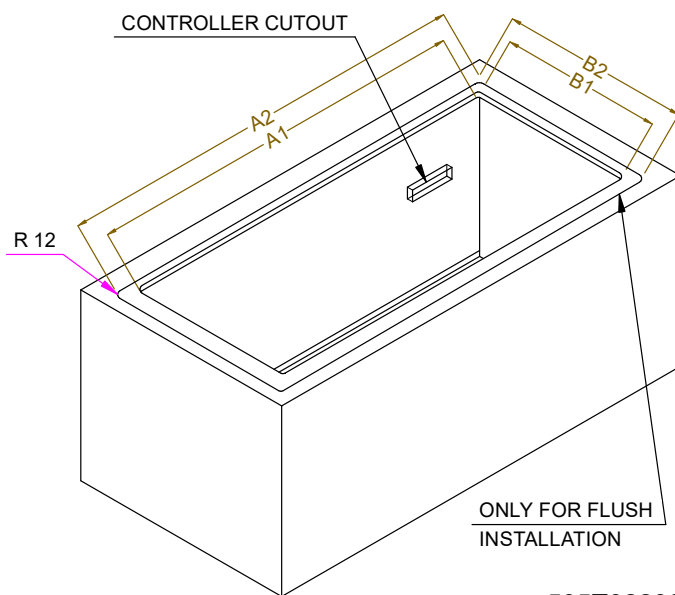

595T02200 - COLD STATIC WELL WITH FAN REM.